



FUSION



OWNER'S MANUAL

W W W . D A N G E R O U S P O W E R . C O M



## **A WORD FROM OUR ENGINEERS AND DESIGN TEAM**

OUR CHALLENGE WAS TO BLEND THE ART OF METAL SCULPTURE WITH MASTERFUL ELECTRONICS IN A PACKAGE THAT SYMBOLIZES STRENGTH, POWER, AND DEXTERITY.

BUILT WITH PASSION, THE DP FX WAS UNLEASHED.

**CONGRATULATIONS ON OWNING THE MOST  
ADVANCED PAINTBALL MARKER ON THE PLANET.**

# INNOVATIVE FEATURES

- **Grip frame OLED.** Innovative stocked fully programmable micro-switch OLED board for your viewing (and playing) pleasure.
- **Ultra sharp OLED display.** The sharpest OLED display in its class, providing a high contrast (2000:1), high resolution (192 x 32), and extremely power efficient display screen.
- **Configurable modes.** Rule change "immune" Tournament Modes that are fully user configurable. Flexible for all levels and modes of play.
- **Comprehensive Breakout Mode Controls.** Provides the most flexible and creative recreational play and training operations available.
- Ultra low-profile **Clamping Feedneck.** That's right - the clamping feedneck that is widely used throughout the paintball industry was originally designed by the folks at DP Engineering. (U.S. Patent - US7252080B2)
- **RAPS™** (Rapid Air Pressurizing System) Flip Lever Style ASA. This revolutionary ASA makes standard twist-knob ASAs a thing of the past. Another DP Engineering original. (U.S. Patent - US7156135)
- **SwitchBlade™ Trigger.** Customize your game plan by flipping the trigger to the desired side, no tools necessary and Adjustable magnetic ball bearing trigger. Two amazing triggers in one - priceless. (U.S. Patent Pending)

- Extremely light weight body (1.94 lbs with barrel, patented RAPS ASA, clamping feedneck and battery).
- High precision light weight 3-D milled aluminum alloy body and accents.
- Light weight interlocking ported two piece barrel.
- Technology surface TiN treatment for Ram/Hammer, lower friction with marker body.



## WARNINGS

### IMPORTANT SAFETY INSTRUCTIONS AND GUIDELINES!

1. The DP FX is NOT A TOY. Treat it with the same respect and care you would a firearm.
2. Carelessness, misuse, and failure to adhere to the warning and guidelines printed in this Owner's Manual may result in property damage, injury, or death. User assumes all risks associated with use of the DP FX.
3. Always ensure that proper safety gear - eyes, face, ear, and head protection - conforming to ASTM standard F1776 (USA) or CE (Europe) are worn at all times when paintballs are within range.
4. Persons under the age of 18 must have adult supervision at all times during use of the FX, or any paintball firing device.
5. Observe all local and national laws regarding rules and regulations.
6. The FX should only be used on a permitted and regulated paintball field where safety rules and guidelines are strictly enforced.
7. Only use compressed air or nitrogen. DO NOT USE CO2!
8. Only use high quality, .68 caliber paintballs.
9. Never point your FX at an unintended target.
10. Always treat your FX as if it were loaded.
11. Keep your FX turned OFF until ready to use.
12. Always measure the velocity of paintballs from your FX with a suitable chronograph device before play.
13. Never look down the barrel or breech area of the FX without first ensuring that the marker is switched to the OFF position, with NO AIR in the marker.  
  
NOTE- SEE NOTE ON PAGE 3 FOR DIRECTIONS ON REMOVING RESIDUAL AIR FROM A POWERED 'OFF' MARKER.
14. Never put any body parts or foreign objects into the breech or feed tube.

## WARNINGS

### IMPORTANT SAFETY INSTRUCTIONS AND GUIDELINES!

15. Always use the supplied barrel cover when your FX is not in use at the field. Doing so will help secure the safety of yourself and those around you.
  16. Never allow pressurized gas to come into contact with your body. Serious harm, injury, or death may occur.
  17. When not in use, always turn your FX to the OFF position.
  18. Promptly remove any paintballs from your FX when not in use.
  19. Always remember to remove residual air from your FX before attempting maintenance or service.
  20. Always remember to remove residual air from your FX before storage or transportation.
- NOTE- POWERING 'OFF' THE MARKER WILL NOT AUTOMATICALLY REMOVE RESIDUAL AIR. TO SAFELY REMOVE RESIDUAL AIR, PLEASE DO THE FOLLOWING:
- A. Remove loader and paintballs from marker.
  - B. Turn Eye Sensors to the OFF position.
  - C. Point marker in a safe direction.
  - D. Fire marker until all residual gas is removed.
21. Always store your FX in a safe place.
  22. Do not discard the Owner's Manual. In the event of transfer or resale, this guide must accompany the marker.
  23. When in doubt, ALWAYS seek expert advice by contacting a reputable airsmith familiar with paintball markers, or by contacting DP Engineering's Customer Service Staff.



# CONTENTS

- 8 GETTING TO KNOW YOUR FX
- 9 FX PARTS LIST
- 10 INLINE REGULATOR
- 11 OPR PARTS LIST
- 12 EVERYTHING YOU NEED TO GET STARTED
- 12 INSTALLING THE BATTERY
- 13 ATTACHING A PAINTBALL LOADER
- 14 CONNECTING MACRO-LINE TO HIGH PRESSURE REGULATOR AND QUICK RELEASE FLIP LEVER ASA (RAPSTM™)
- 15 ATTACHING AIR TANK TO RAPSTM™ FLIP LEVER ASA
- 16 SWITCHING YOUR FX ON/OFF
- 16 TURNING EYES ON/OFF
- 17 FIRING YOUR FX
- 18 VELOCITY ADJUSTMENT
- 19 TRIGGER ADJUSTMENT
- 22 FX CIRCUIT BOARD PROGRAMMING FLOW-CHART
- 24 PROGRAMMING YOUR FX
- 24 MENU NAVIGATION
- 25 START MENU
  - 25 PROFILE LOAD MENU
  - 25 HOT START MENU
  - 26 PROGRAM MENU
  - 26 TRIGGER TRAINER MODE (TTM)
  - 27 STATISTICS
- 28 PROFILE LOAD MENU
- 28 GLOBAL SETUP MENU
  - 28 1.GLOBAL SETPOINTS
  - 29 2.BREAKOUT MODE
  - 31 3.TOURNEY RULES
- 32 RESET MENU
- 33 MARKER SETPOINTS
- 35 FIRING SETPOINTS
- 38 FIRING MODE ENABLE
- 40 CARE AND MAINTENANCE
  - 40 DEGASSING THE FX
- 42 CLEANING THE EYE-SENSOR BREAK BEAM SYSTEM
- 44 CLEANING THE BALL DETENTS
- 45 OPERATING PRESSURE REGULATOR (OPR) DISASSEMBLY AND MAINTENANCE
  - 45 GENERAL DISASSEMBLY OF OPR
  - 48 CLEANING AND MAINTENANCE OF OPR
- 50 CLEANING THE AIR CHAMBER MODULE
- 52 MAINTAINING THE RAMMER
- 54 SEPARATING FX BODY FROM TRIGGER FRAME
- 55 SOLENOID MAINTENANCE
- 57 REMOVING SWITCHBLADE™ TRIGGER FROM FRAME
- 58 RAPSTM™ FLIP LEVER ASA REMOVAL AND MAINTENANCE
- 62 TROUBLESHOOTING
- 64 PARTS DIAGRAM AND TABLE
- 66 STATEMENT OF LIABILITY
- 66 DISCLAIMER
- 67 LIMITED LIFETIME WARRANTY



## GETTING TO KNOW YOUR FX

Your FX is a sophisticated piece of machinery, designed for superior performance along with ease of use and maintenance. For maximum enjoyment and safety while using your FX, please take the time to acquaint yourself with its operation, controls, programmable features, and care and maintenance instructions found in this Owner's Manual.



## FX PARTS LIST

- A. Feedneck
- B. Body
- C. Bolt
- D. Bolt Pin
- E. Air Chamber Cap
- F. Spring Ring
- G. Valve Pin Spring
- H. Valve Pin
- I. Ram Spring
- J. Ram/Hammer
- K. Ram Cap
- L. Solenoid
- M. Operating Pressure Regulator
- N. Elbow
- O. Trigger Frame
- P. Trigger Set Screw
- Q. Trigger
- R. Grip
- S. OLED Window
- T. Body Set Screw
- U. Body Set Screw
- V. Rapid Air Pressurize System (R.A.P.S.)

## INLINE REGULATOR

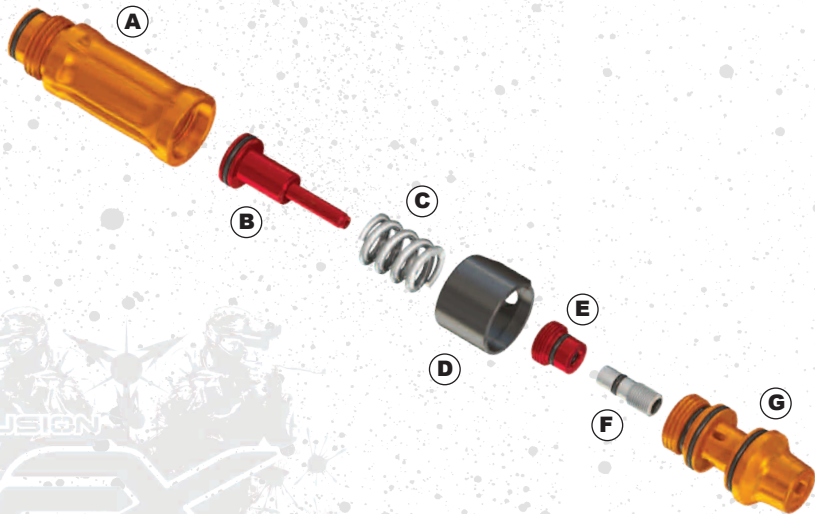

## OPR PARTS LIST

- A. Operating Pressure Regulator Body
- B. Regulator Piston
- C. Regulator Spring
- D. Regulator Ring
- E. Piston Seal
- F. Regulator Adjustment Screw
- G. Regulator Bottom Cap

## EVERYTHING YOU NEED TO GET STARTED

Prepare the following items in order to begin using your FX:

- One 9V battery. Be sure that the battery is fresh and from a reputable manufacturer.
- Paintball loading device. (Recommended minimum load rate of 25 BPS)
- .68 caliber paintballs. Always use fresh, high-quality paint with proper bore size for best results.
- Approved air tank utilizing COMPRESSED AIR or NITROGEN ONLY.

### WARNING

THE FX USE NITROGEN OR COMPRESS AIR ONLY, DO NOT USE CO2.

## INSTALLING THE BATTERY

- Carefully remove the 2 hexagonal screws (3/32") holding the left panel in place.
- Locate battery harness and attach 9V battery to the connector pad. Do not use force!
- Replace battery in grip frame as shown in illustration A.
- Replace grip frame and screws. Do not over tighten screws!



## ATTACHING A PAINTBALL LOADER

- Release clamp on feedneck. (SEE PIC A)
- Loosen thumbscrew counterclockwise by hand. (SEE PIC B)
- Insert feed tube of loader unit.
- Close clamp securely. Loader should fit snug within feedneck. (SEE PIC C)
- If loader is loose, remove and adjust thumbscrew clockwise.

### WARNING

EXCESSIVE FORCE MAY CAUSE DAMAGE TO LOADER OR THE FX!



## CONNECTING MACRO-LINE TO HIGH PRESSURE REGULATOR AND QUICK RELEASE FLIP LEVER ASA (RAPSTM)

- Pull back the collet section of the macro-line elbow located on your RAPSTM ASA. (SEE PIC A)
- Keeping the collet back, insert macro-line hose firmly into the fitting and release the collet. Be sure that the hose is seated all the way into the end of elbow fitting. (SEE PIC B . C)
- Repeat the same process on the macro-line elbow located on your OPR to connect the RAPSTM ASA.

### WARNING

IMPROPER FITMENT WILL CAUSE PHYSICAL INJURY. ALWAYS INSPECT MACRO-LINE HOSE SEATED ALL THE WAY INTO THE END OF THE ELBOW.

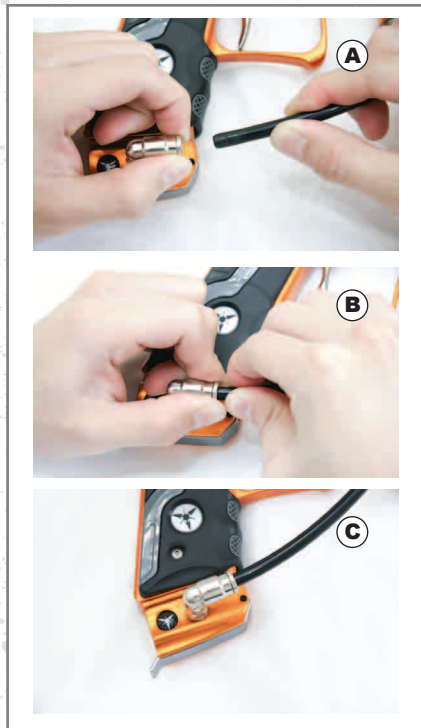

## ATTACHING AIR TANK TO RAPSTM FLIP LEVER ASA

- Swing flip lever to the 'release' position. (SEE PIC B)
- Attach air tank by carefully screwing it into the threaded portion of the RAPSTM ASA. Make sure tank fitment is tight and all the way in. (SEE PIC C)
- Return flip lever of the RAPSTM ASA to the 'close' position. (SEE PIC D)
- A brief sound of air entering the system is normal. The FX is now pressurized. (SEE PIC E)



### WARNING

ALWAYS USE THE SUPPLIED BARREL COVER BEFORE AIR UP YOUR FX WHEN IT IS NOT IN USE AT THE FIELD. DOING SO WILL HELP SECURE THE SAFETY OF YOURSELF AND THOSE AROUND YOU. (SEE PIC A)

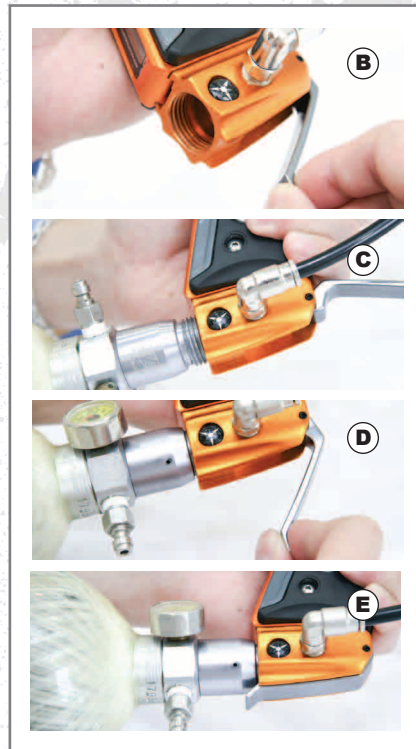

## SWITCHING YOUR FX ON/OFF

- Press and hold the Power Button until the FX turns on. Release the power button to continue.
- To power OFF your FX, press and hold the Power Button until your marker shuts off.

## TURNING EYES ON/OFF

- The FX use a break beam eyes sensor system to detect paintball in the firing position. When the eye sensors are turn on, the circuit board will inhibit the firing of the bolt when no paintball has detected. This prevents unintended paintball break age in the breech of the marker. For optimum results during play, always leave the eyes in the 'ON' position. When 'DRY FIRING', it will be necessary to switch the eye sensors to the 'OFF' position.
- Tap the Eye Button to toggle the eye function between ON or OFF. Your marker will display the 'EYES ON' icon on the OLED display when enabled and will fire at the 'EYES ON' rate of fire.
- When the eye function is disabled, the 'EYES OFF' icon will appear on the OLED display and your marker will fire at the 'EYES OFF' rate of fire.

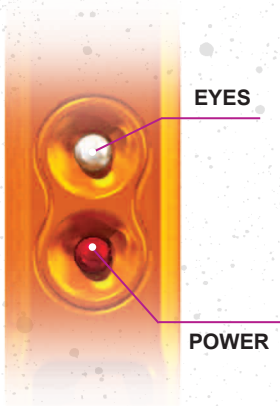

## FIRING YOUR FX

- While the FX is ON, tap the Power Button to scroll thru all the enabled firing modes.
- Select desired firing mode.
- Depress the trigger to fire the FX.
- The entire firing operation can be programmed electronically for optimal results.

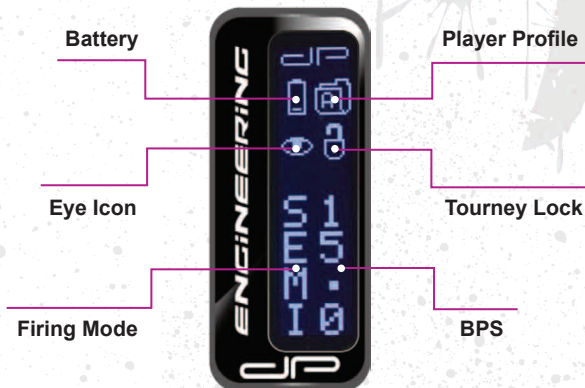

## VELOCITY ADJUSTMENT

- Locate the (1/8") allen key wrench included with your FX.
- Adjust screw located at the bottom of Operating Pressure Regulator (OPR) to increase or decrease velocity. (SEE PIC A)
- Turn screw counterclockwise towards the (+) sign to increase velocity. (SEE PIC B)
- Turn screw clockwise towards the (-) sign to decrease velocity.



### WARNING

DP ENGINEERING RECOMMENDS THAT THE VELOCITY NEVER EXCEED 300 FPS. FAILURE TO FOLLOW REGULATIONS REGARDING MAXIMUM ALLOWABLE VELOCITY, CALCULATED IN FEET PER SECOND (FPS), MAY RESULT IN DAMAGE OF PAINTBALL MARKER, SERIOUS INJURY OR DEATH. BE RESPONSIBLE AND ALWAYS USE A CHRONOGRAPH TO DETERMINE ACCURATE VELOCITY BEFORE PLAY.

## TRIGGER ADJUSTMENT

- Note the three adjustment screws (marked A, B, and C) in the vicinity of the SWITCHBLADE™ Trigger.
- Screw A (5/64") adjusts the amount of trigger travel prior to the marker firing. Turning this screw clockwise will reduce the amount of trigger travel. Turning this screw counterclockwise will increase the amount of trigger travel. (SEE PIC A)
- Screw B (5/64") sets the amount of trigger travel after the marker has been fired. Turning the screw clockwise will reduce the amount of trigger travel. Turning the screw counterclockwise will increase the amount of trigger travel. (SEE PIC B)



### NOTE

NOT TO TURN THE SCREW TOO FAR IN EITHER DIRECTION, DOING SO MAY PUSH THE TRIGGER PAST THE FIRING POINT AND CAUSE OPERATIONAL FAILURE.

## TRIGGER ADJUSTMENT (CONTINUED)

- Screw C (3/32") adjusts the strength of the trigger's return to rest by either reducing or increasing the magnetic pull. Turning this screw counterclockwise will decrease the strength. Turning this screw clockwise will increase the strength. Do not turn the screw too far - doing so may weaken the magnetic pull and prevent the trigger from being able to fully return to rest. (SEE PIC C)



- FX's SWITCHBLADE™ Trigger. This revolutionary trigger system allows the user to quickly switch between two trigger styles without the use of tools or disassembly. Simply flip the trigger and lock in place the desired trigger style. (SEE PIC A . B . C)

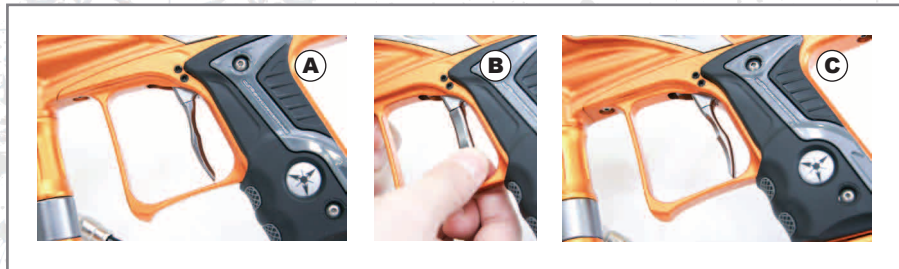

# FX CIRCUIT BOARD PROGRAMMING FLOW-CHART

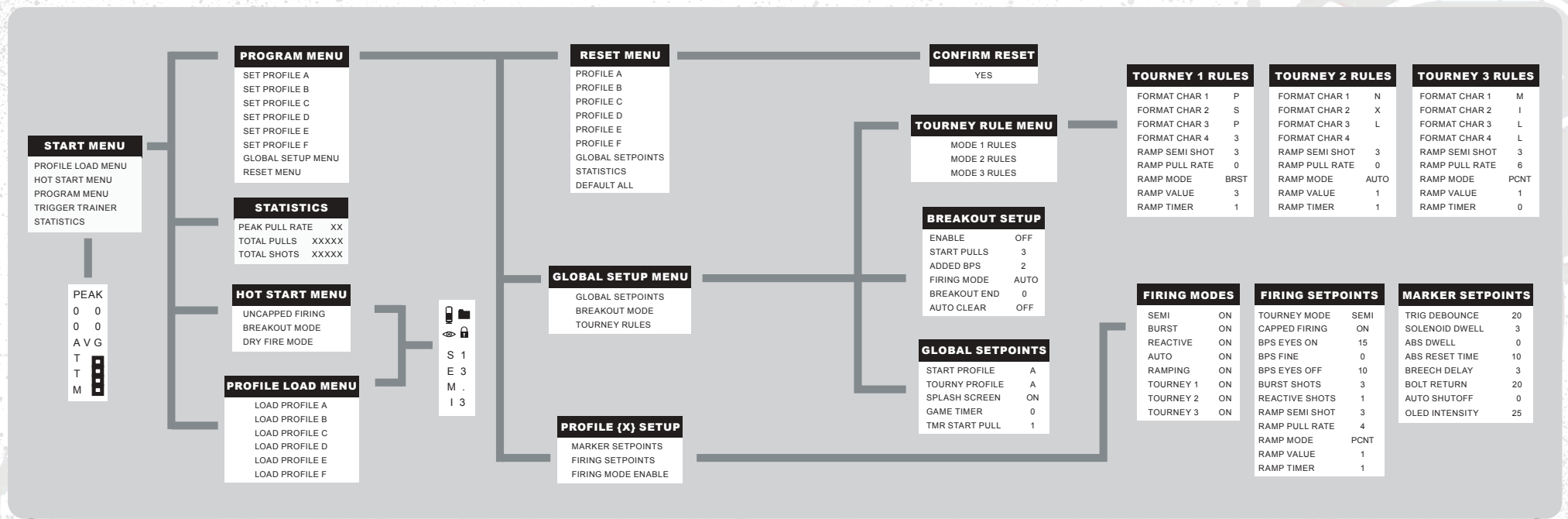

**START MENU**  
 PROFILE LOAD MENU  
 HOT START MENU  
 PROGRAM MENU  
 TRIGGER TRAINER  
 STATISTICS

PEAK  
 0 0  
 0 0  
 A V G  
 T  
 T  
 M

**PROGRAM MENU**  
 SET PROFILE A  
 SET PROFILE B  
 SET PROFILE C  
 SET PROFILE D  
 SET PROFILE E  
 SET PROFILE F  
 GLOBAL SETUP MENU  
 RESET MENU

**STATISTICS**  
 PEAK PULL RATE XX  
 TOTAL PULLS XXXXX  
 TOTAL SHOTS XXXXX

**HOT START MENU**  
 UNCAPPED FIRING  
 BREAKOUT MODE  
 DRY FIRE MODE

**PROFILE LOAD MENU**  
 LOAD PROFILE A  
 LOAD PROFILE B  
 LOAD PROFILE C  
 LOAD PROFILE D  
 LOAD PROFILE E  
 LOAD PROFILE F

S 1  
 E 3  
 M .  
 I 3

**RESET MENU**  
 PROFILE A  
 PROFILE B  
 PROFILE C  
 PROFILE D  
 PROFILE E  
 PROFILE F  
 GLOBAL SETPOINTS  
 STATISTICS  
 DEFAULT ALL

**GLOBAL SETUP MENU**  
 GLOBAL SETPOINTS  
 BREAKOUT MODE  
 TOURNEY RULES

**PROFILE (X) SETUP**  
 MARKER SETPOINTS  
 FIRING SETPOINTS  
 FIRING MODE ENABLE

**CONFIRM RESET**  
 YES

**TOURNEY RULE MENU**  
 MODE 1 RULES  
 MODE 2 RULES  
 MODE 3 RULES

**BREAKOUT SETUP**  
 ENABLE OFF  
 START PULLS 3  
 ADDED BPS 2  
 FIRING MODE AUTO  
 BREAKOUT END 0  
 AUTO CLEAR OFF

**GLOBAL SETPOINTS**  
 START PROFILE A  
 TOURNEY PROFILE A  
 SPLASH SCREEN ON  
 GAME TIMER 0  
 TMR START PULL 1

**TOURNEY 1 RULES**  
 FORMAT CHAR 1 P  
 FORMAT CHAR 2 S  
 FORMAT CHAR 3 P  
 FORMAT CHAR 4 3  
 RAMP SEMI SHOT 3  
 RAMP PULL RATE 0  
 RAMP MODE BRST  
 RAMP VALUE 3  
 RAMP TIMER 1

**TOURNEY 2 RULES**  
 FORMAT CHAR 1 N  
 FORMAT CHAR 2 X  
 FORMAT CHAR 3 L  
 FORMAT CHAR 4  
 RAMP SEMI SHOT 3  
 RAMP PULL RATE 0  
 RAMP MODE AUTO  
 RAMP VALUE 1  
 RAMP TIMER 1

**TOURNEY 3 RULES**  
 FORMAT CHAR 1 M  
 FORMAT CHAR 2 I  
 FORMAT CHAR 3 L  
 FORMAT CHAR 4 L  
 RAMP SEMI SHOT 3  
 RAMP PULL RATE 6  
 RAMP MODE PCNT  
 RAMP VALUE 1  
 RAMP TIMER 0

**FIRING MODES**  
 SEMI ON  
 BURST ON  
 REACTIVE ON  
 AUTO ON  
 RAMPING ON  
 TOURNEY 1 ON  
 TOURNEY 2 ON  
 TOURNEY 3 ON

**FIRING SETPOINTS**  
 TOURNEY MODE SEMI  
 CAPPED FIRING ON  
 BPS EYES ON 15  
 BPS FINE 0  
 BPS EYES OFF 10  
 BURST SHOTS 3  
 REACTIVE SHOTS 1  
 RAMP SEMI SHOT 3  
 RAMP PULL RATE 4  
 RAMP MODE PCNT  
 RAMP VALUE 1  
 RAMP TIMER 1

**MARKER SETPOINTS**  
 TRIG DEBOUNCE 20  
 SOLENOID DWELL 3  
 ABS DWELL 0  
 ABS RESET TIME 10  
 BREECH DELAY 3  
 BOLT RETURN 20  
 AUTO SHUTOFF 0  
 OLED INTENSITY 25



## PROGRAMMING YOUR FX

Please refer to FX Circuit Board Programming Flow-Chart for a complete overview.

To enter Programming Mode, POWER ON the FX while pulling the trigger down. Release the power button and trigger to continue.

### NOTE

YOUR MARKER WILL NOT START IN PROGRAMMING MODE IF THE TOURNEY MODE LOCK SWITCH (SEE PAGE 35) IS IN THE 'ON' POSITION.

To exit Programming Mode, either POWER OFF the FX or scroll through modes until the 'x' appears in the upper right corner of the screen. When the 'x' is displayed, pull and hold the trigger to return to live firing mode.

## MENU NAVIGATION

Pull and release the trigger to scroll through the available menu options. An arrow on the left side of the display will indicate your current selection. To select a menu option, simply pull and hold the trigger. To adjust the setpoint, tap the Power Button to increase the value or tap the Eye Button to decrease the value. Once the desired setpoint value is reached, simply scroll to another setpoint, or exit. Once you scroll past the last option in a menu, a "Back Arrow" icon will appear in the upper left corner of the OLED display. When selected, the "Back Arrow" option returns you to the previous menu.

## START MENU

### Profile Load Menu

This option lets you load a profile. You can define up to six individual profiles. Each profile stores a complete collection of setpoints and allows instant reconfiguration of settings and preferences.



### Hot Start Menu

This option lets you quickly access the following options:

- **Uncapped Firing:**  
Instantly uncaps the rate of fire on your marker.
- **Breakout Mode:**  
Instantly turns on the currently defined Breakout Mode.
- **Dry Fire Demo:**  
Instantly bypasses all eye processing on your marker and fires at the 'EYES ON' rate of fire.



## START MENU (CONTINUED)

### Program Menu

This menu provides access to all the marker set-points. Each time the marker is programmed, the settings are stored into a unique profile. You can program up to six individual profiles. From this menu you can also access the Global Set-points (those that apply to all marker operations), the Tuning Assist function and the Reset Menu.



### Trigger Trainer Mode (TTM)

This option puts you into "training" mode that lets you measure how fast you can pull the trigger. This mode will capture your Average and Peak pull rates, and display a bar graph based on your current pull rate. To start a training cycle, pull the trigger repeatedly for a short burst. When you stop pulling, the marker will update the OLED display with your pull rate data. Pull another trigger burst to measure your rate again.



## START MENU (CONTINUED)

### Statistics

This option displays the following statistical information about your marker:



#### - Peak Pull Rate

This displays the highest pull rate achieved since the last reset.

#### - Total Pulls

This displays the total number of trigger pulls since the last reset.

#### - Total Shots

This displays the total number of bolt cycles / shots fired since the last reset.

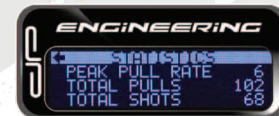

*All of these statistical counters can be reset to zero from the "Reset Menu".*



## PROFILE LOAD MENU

This option allows you to choose which profile you wish to load should you want to manually override the "Start Profile" setpoint in the Global Setpoint section.

## GLOBAL SETUP MENU

Start Menu > Program Menu > Global Setup Menu

This menu provides access to setpoints that apply to all profiles and marker operations. They are organized into three groups:

### 1.Global Setpoints

Start Menu > Program Menu > Global Setup Menu > Global Setpoint

#### - Start Profile

This setpoint determines which profile your marker will use when it starts.

#### - Tourney Profile

This setpoint determines which profile your marker will use when the TOURNEY MODE LOCK SWITCH is set to 'ON'.

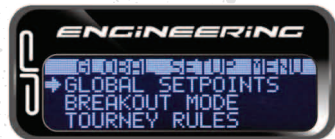

## GLOBAL SETUP MENU (CONTINUED)

#### - Splash Screen

This determines if the splash screen is displayed at marker startup.

#### - Game Timer

Sets the time (in minutes) for your game timer. A value of zero disables the game timer feature.

#### - TMR Start Pull

Determines which trigger pull will start the game timer after marker start up. This allows you to fire "x" number of clearing shots without starting the timer.

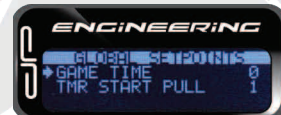

### 2.Breakout Mode

These setpoints allow you to define your own custom Breakout Mode:



## GLOBAL SETUP MENU (CONTINUED)

- **Enabled**  
This setpoint turns on/off the Breakout Mode operation.
- **Start Pulls**  
Enable the Breakout Mode to choose which trigger pull will activate this mode.
- **Added BPS**  
While the Breakout Mode is active, this setpoint lets you add additional balls per second to your programmed rate of fire.
- **Firing Mode**  
This sets the mode the marker will fire in once Breakout Mode is activated.
- **Breakout End**  
This setpoint lets you choose how the Breakout Mode will end. Choose 0 to end the Breakout Mode operation once the trigger is idle 0.2 seconds, or choose the length of time (in seconds) the Breakout Mode will remain active.

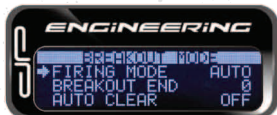
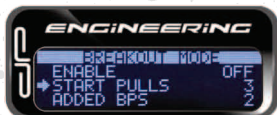
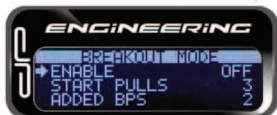

## GLOBAL SETUP MENU (CONTINUED)

- **Auto Clear**  
When this is set to ON, the Breakout function will have to be re-enabled via the programming menu or through the Hot Start option. If Auto Clear is set to OFF, simply power cycle your marker to re-enable the Breakout mode.

### 3. Tourney Rules

Start Menu > Program Menu > Global Setup Menu > Tourney Rules

The FX provides fully programmable tournament operations, allowing you to stay compliant in the event of any future tournament rule changes. Default support is provided for PSP, NXL and Millennium tournament formats. The user can also reconfigure these rules for other tournament formats or any new tournament format that is adopted in the future.

- **Ramp Semi Shots**  
Defines the number of semi shots required before any ramping is allowed.
- **Ramp Pull Rate**  
This is the trigger pull rate (trigger pulls per second) that needs to be achieved before ramping. Any semi shots defined must first be satisfied prior to ramping by pull rate. If this setpoint is zero, the marker will ramp immediately after the defined number of semishots are satisfied.

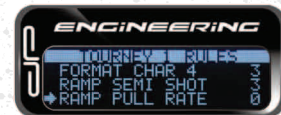
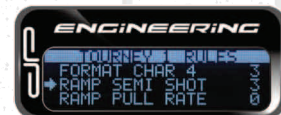

## GLOBAL SETUP MENU (CONTINUED)

### - Ramp Mode

Determines which firing mode to ramp to: Burst, Reactive, Full Auto, or Percent ramping.

### - Ramp Value

In Burst Mode, it is the number of shots in a burst. In Reactive Mode, it is the number of shots fired with each trigger pull and release. In Percent ramping, it is the percentage of ramping used (Percentage = Ramp Firing Value x 100).

### - Ramp Timer

Determines the amount of time the trigger can be at rest and still remain in the current ramping stage before reverting back to Semi Mode. This time value is entered in seconds. If this setpoint is zero, it will reset ramping when the trigger is released, or when your trigger pull rate drops below the Ramp Pull Rate setpoint.



## RESET MENU

Start Menu > Program Menu > Reset Menu

The Reset Menu allows you to individually reset profiles, statistics, or your entire marker to factory default settings. Trigger scroll to the item you want to reset. To select the item you wish to reset, pull and hold the trigger. A confirmation screen will then ask you to confirm that you want to reset the item. Pull and hold to confirm.



## MARKER SETPOINTS

Start Menu > Program Menu > Set Profile (x) > Marker Setpoints

### - Trigger Debounce

This value sets amount of time (in milliseconds) the trigger must remain inactive prior to accepting a new trigger pull. Lowering this value can cause your marker to fire erratically when making successive trigger pulls. Raising this value will prevent erratic firing and provide reliable firing in sync with your trigger pulls.

### - Solenoid Dwell

This setting allows you to adjust how long the solenoid is energized (in milliseconds). Higher Dwell times will consume more power and air when the solenoid is energized. Lower Dwell times consume less power when the solenoid is energized. Lowering this value too much may prevent the solenoid valve from opening altogether.

### - Anti Bolt Stick Dwell

This setting allows you to add additional Dwell time (in milliseconds) to your solenoid Dwell setting. This will only affect the first shot fired after the Bolt Stick Reset Time is exceeded.

### NOTE

YOU SHOULD ONLY USE THIS SETTING IF YOU EXPERIENCE FIRST SHOT DROP OFF.



## MARKER SETPOINTS (CONTINUED)

Start Menu > Program Menu > Set Profile (x) > Marker Setpoints

### - Anti Bolt Stick Reset Time

This setting allows you to set the amount of time the trigger can remain idle before adding the Bolt Stick Dwell setting. This value is ignored if the Bolt Stick Dwell is zero.

### - Breech Load Delay

This setpoint establishes the amount of time (in milliseconds) between the eyes sensing the ball in the breech and activation of the bolt. This ensures a ball has dropped fully into the breech before the marker fires.

### - Bolt Return Delay

This setpoint establishes the amount of time (in milliseconds) after firing a round that the marker waits to see the bolt transition back past the eyes. This value can be lowered when using high performance aftermarket bolts or when a proper tuning procedure is performed.

### - Auto Shut Off

Allows you to adjust if or when your marker will automatically POWER OFF after no firing activity. Auto Shutoff values range from 0 to 60, with each increment adding 1 minute of time to the delay (1 to 60 min.). A value of 0 defeats the Auto Shutoff feature, and your marker will remain on until you manually POWER OFF.

### - OLED Intensity

Allows you to change the intensity level of your OLED display.



## FIRING SETPOINTS

Start Menu > Program Menu > Set Profile (x) > Firing Setpoints

### - Tourney Mode

Determines what mode will be used for tournament play when the Tourney Mode Lock Switch is ON. Activate the Tournament Mode by placing the switch in the 'ON' position and power cycling the marker. Tournament Mode deactivates all programming operations.

### Tourney Mode Lock Switch

To access this switch, remove grip from the grip frame using supplied allen key wrench (3/32"). In OLED display back side, you will see a small tiny switch. By default, the switch will be in the 'OFF' position (to the right), Shown in illustration. To turn the switch to the 'ON' position, carefully nudge the switch using a small sharp object towards the dot (on the left).

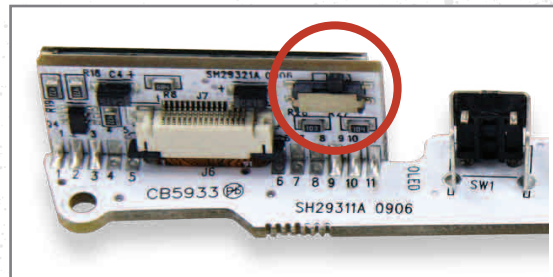

## FIRING SETPOINTS (CONTINUED)

Start Menu > Program Menu > Set Profile (x) > Firing Setpoints

### - Capped Firing

This option allows you to cap the firing rate at the BPS 'EYES ON' setpoint. If you wish to fire your marker uncapped at its highest mechanical rate of fire, you can turn the option OFF.

### - BPS Eyes On

This sets the 'EYES ON' rate of fire in BPS (balls per second) for all firing modes.

### - BPS Fine

This adds a fractional BPS to the BPS 'EYES ON' setting. For example, a value of 1 would add .1 to the BPS 'EYES ON' rate of fire.

### - BPS Eyes Off

This sets the 'EYES OFF' rate of fire in BPS (balls per second) for all firing modes.

### - Burst Shots

This value sets the number of rounds fired for each trigger pull in Burst Mode.

### - Reactive Shots

This value sets the number of rounds fired for each trigger pull and release in Reactive Mode.

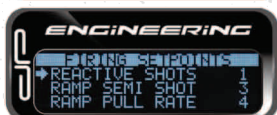
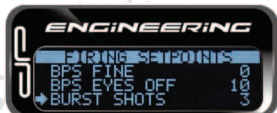

## FIRING SETPOINTS (CONTINUED)

Start Menu > Program Menu > Set Profile (x) > Firing Setpoints

### - Ramp Semi Shot

Defines the number of semi shots required before any ramping is allowed.

### - Ramp Pull Rate

This is the trigger pull rate (trigger pulls per second) that needs to be achieved before ramping. Any semi shots defined must first be satisfied prior to ramping by pull rate. Likewise, if this setpoint is zero, the marker will ramp immediately after the defined number of semi shots are satisfied.

### - Ramp Mode

Determines which firing mode to ramp to: Burst, Reactive, Full Auto, or Percent ramping.

### - Ramp Value

This value is associated with the Ramp Mode. In Burst Mode, it is the number of shots in a burst. In Reactive Mode, it is the number of shots fired with each trigger pull and release. In Percent ramping, it is the percentage of ramping used (Ramp Firing Value x 100).

### - Ramp Timer

Determines the amount of time the trigger can be at rest and still remain in the current ramping stage before reverting back to Semi Mode. This time value is entered in seconds.

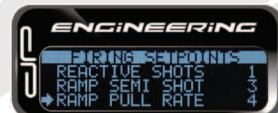

## FIRING MODE ENABLE

Start Menu > Program Menu > Set Profile (x) > Firing Mode Enable

Allows you to enable/disable any firing mode in a profile. A disabled firing mode is skipped when scrolling thru firing modes.



# CARE AND MAINTENANCE

Your FX was designed to be reliable, easy to maintain, and easy to repair. Routine maintenance will ensure many years of performance and enjoyment. When in doubt, always seek the assistance of a certified technician from a reputable pro shop, or contact DP Engineering Customer Service.

## Degassing the FX

Always be sure to completely de-gas your marker before performing maintenance or service repair. Carefully follow the instructions below in sequence to ensure that all remaining air has been removed from the entire operation:

1. Flip the RAPS™ ASA to the "OFF" position, unscrew to disconnect the air tank from the RAPS™ ASA.
2. Remove the paintball loading device and check to make sure there are no paintballs within the breech.
3. Turn the eyes to the "OFF" position and point the marker to a safe direction, then fire 1-2 shots to remove air from the OPR. Be aware that the marker may still fire without an air system attached!
4. POWER OFF the marker.

FUSION

### IMPORTANT NOTES BEFORE SERVICING YOUR MARKER :

- DP ENGINEER SUGGEST YOU ALWAYS USE DP-40 LUBE (SUPPLIED) TO SERVICE YOUR MARKER.
- DO NOT APPLY EXCESSIVE LUBRICANT.
- ALWAYS INSPECT AND CLEAN YOUR MARKER AFTER EACH USE.
- NEVER APPLY EXCESSIVE FORCE WHEN REMOVING OR REPLACING SCREWS. DOING SO MAY STRIP THE SCREW HEADS OR DAMAGE THREADS.
- ALWAYS USE THE CORRECT SIZE AND THE APPROPRIATE TOOLS.
- REFRAIN FROM SUBMERSING ENTIRE MARKER IN LIQUID. KEEP SENSITIVE ELECTRONICS SUCH AS SOLENOID AND CIRCUIT BOARD FREE FROM MOISTURE.
- NEVER ALLOW SOMEONE WHO IS UNFAMILIAR WITH YOUR MARKER TO PERFORM MAINTENANCE OR REPAIR WORK. WHEN IN DOUBT, CONTACT DP ENGINEERING CUSTOMER SERVICE.



## CLEANING THE EYE-SENSOR BREAK BEAM SYSTEM

The function of the break beam sensor eyes is to allow the firing circuit to 'time' the activation of the solenoid. This prevents 'chopping' of paint, which is caused by the bolt cycling within the breech without the paintball being actually seated in the proper firing position. When the eye sensors are ON, the gun will not fire if the beam does not sense a paintball. To ensure proper function, the eye sensors should be cleaned after every other use, or when paintballs have been broken within the marker. More frequent cleaning may be necessary when using paintballs that have 'oily residue' on the surface of the shell. To avoid malfunction, always use fresh and clean paint from a reliable manufacturer.

To clean the eyes:

1. Locate the eye cover plates on either side of your FX body. **(SEE PIC A)**
2. Using provided allen key wrench (5/64"), carefully remove the eye cover screw on one side by inserting ball point tip and turning wrench handle counterclockwise. **(SEE PIC B)**
3. Lift eye cover plate, exposing eye wires, and ball detent. **(SEE PIC C)**

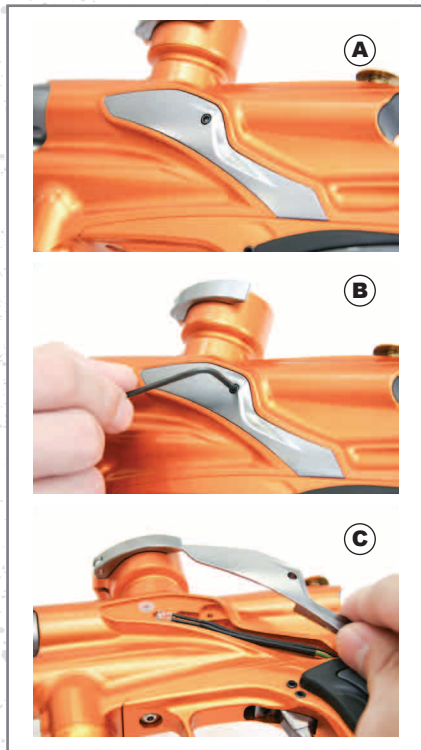

## CLEANING THE EYE-SENSOR BREAK BEAM SYSTEM

(CONTINUED)

4. Carefully pull out the eyes sensors from the socket, do not lose the ball detent and eye cover screw. **(SEE PIC D)**
5. With a cotton swab, gently wipe the back and front side of the eye sensor and the eye socket to remove any debris or residue. **(SEE PIC E)**
6. Replace eye sensors back to original position. Be sure the eyes are aligned correctly and facing the direction of the breech.
7. Replace eye cover plate in original position and gently tighten eye cover screws clockwise. **DO NOT OVERTIGHTEN! (SEE PIC F)**
8. Repeat the same procedure on the other side.

### HELPFUL HINT

DO NOT PULL ON THE EYE WIRES. USE A SMALL PICK OR SCREW DRIVER TO GENTLY LIFT THE WIRES UP. THIS WILL LIFT THE EYE SENSORS OUT OF THE EYE SOCKET.

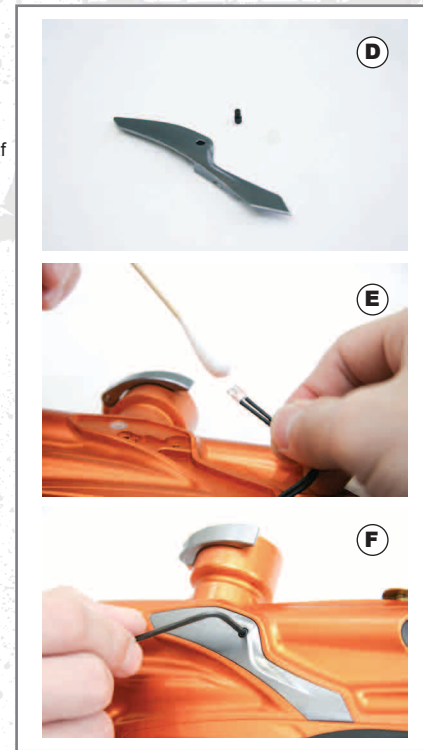

## CLEANING THE BALL DETENTS

The ball detents should be inspected during the cleaning of the eye sensors. Replace these parts should you notice any damage, no matter how slight.

1. Locate the eye cover plates on either side of your FX body.
2. Using provided allen key wrench (5/64"), carefully remove the eye cover screw on one side by inserting ball point tip and turning wrench handle counterclockwise. (SEE PIC A)
3. Place finger within breech, and gently push on the detent from the inside of marker body. Remove ball detent. (SEE PIC B)
4. With a cotton swab, clean ball detent, and detent groove. (SEE PIC C)
5. Replace detent back to original position, with the circular side down towards the breech.
6. Replace eye cover plate in original position and gently tighten eye cover screws clockwise. DO NOT OVERTIGHTEN! (SEE PIC D)
7. Repeat the same procedure on the other side.



## OPERATING PRESSURE REGULATOR (OPR) DISASSEMBLY AND MAINTENANCE

As its name implies, the OPR regulates the amount of air-flow, which determines paintball velocity. Regular inspection and cleaning of your OPR is an essential part of keeping your FX running in top condition. Follow the easy steps outlined below to ensure that your OPR remains trouble-free.

### GENERAL DISASSEMBLY OF OPR

1. Before disassembly of your regulator, be sure to disconnect the macro-line hose from the elbow fitting attached to your regulator. This is accomplished by pulling back on the collet of the elbow fitting, while simultaneously pulling the macro-line out to remove.
2. With a firm hold on the Regulator Body, unscrew by hand the entire unit in a counterclockwise direction. If the OPR unit is difficult to turn by hand, a rubber strap wrench available in most hardware stores may be used. (SEE PIC A)

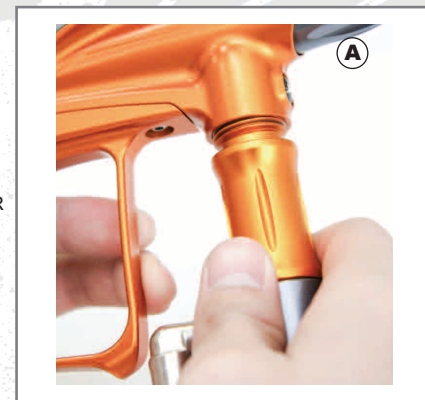

#### NOTE

DO NOT UNSCREW BY USING WRENCH OR PLIERS, AS DOING SO MAY SCRATCH AND DAMAGE THE ANODIZED SURFACE.

## OPERATING PRESSURE REGULATOR (OPR) DISASSEMBLY AND MAINTENANCE (CONTIUNED)

3. By hand or with the assistance of a allen key wrench (1/4"), unscrew the OPR from the Regulator Bottom Cap. (SEE PIC B)
4. Take out Regulator Piston and remove Regulator Spring. (SEE PIC C)
5. Carefully disassembly Regulator Piston and Regulator Spring. (SEE PIC D)
6. Using supplied allen key wrench (1/4") and (7/32"), carefully disassembly the Regulator Bottom Cap and Piston Seal with turning wrench handle counterclockwise. (SEE PIC E . F)



## OPERATING PRESSURE REGULATOR (OPR) DISASSEMBLY AND MAINTENANCE (CONTIUNED)

7. Using supplied allen key wrench (1/8") turn clockwise to remove Regulator Adjustment Screw. (SEE PIC G . H)
8. Inline Regulator assembly arrangement shown in illustrated I.

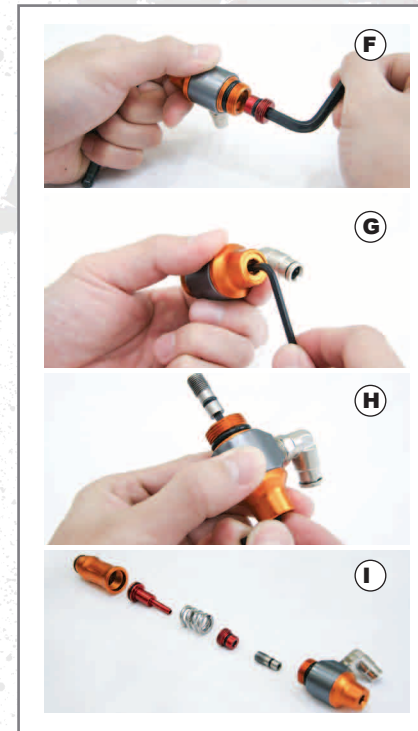

## OPERATING PRESSURE REGULATOR (OPR) DISASSEMBLY AND MAINTENANCE (CONTIUNED)

### CLEANING AND MAINTENANCE OF OPR

1. Remove all visible debris and dirt with a lightly dampened and clean cotton cloth. Not to scratch the surface of any regulator parts.
2. Lightly apply a small amount of DP-40 lubricant to the tip of a cotton swab. (SEE PIC A)
3. Apply lubricant to the o-ring located on the base of the Regulator Adjustment Screw. (SEE PIC B)

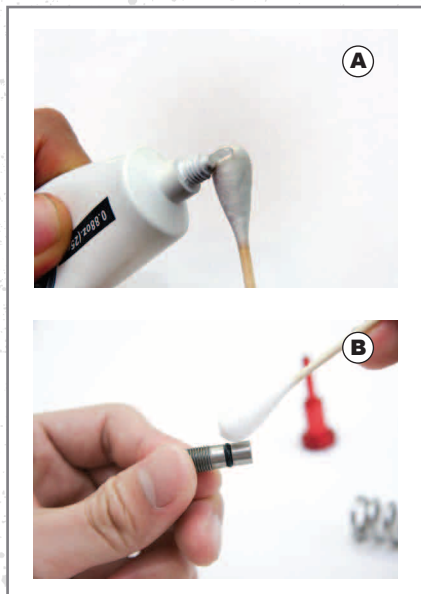

## OPERATING PRESSURE REGULATOR (OPR) DISASSEMBLY AND MAINTENANCE (CONTIUNED)

4. Apply lubricant to the o-ring located on the base of the Regulator Piston. (SEE PIC C)
5. Apply lubricant to the 2 o-ring located on the Piston Seal. (SEE PIC D . E)

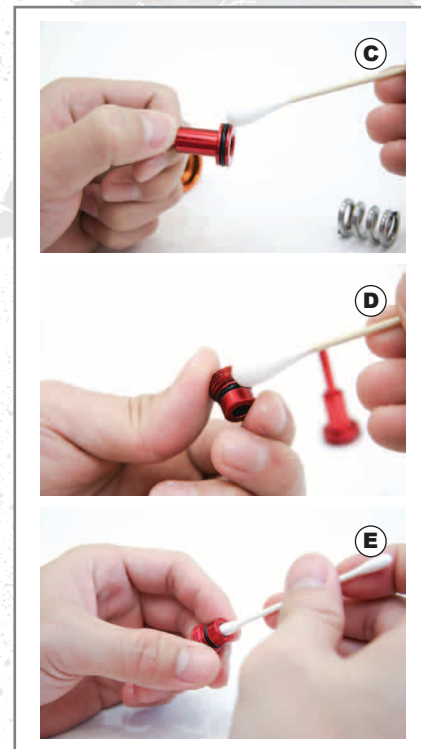

#### NOTE

CAREFULLY INSPECT O-RING PRIOR TO APPLYING LUBRICANT. REPLACE IF O-RING APPEARS WORN, CRACKED, TORN, OR DAMAGED.



## CLEANING THE AIR CHAMBER MODULE

1. Insert supplied allen wrench (5/32") in the Air Chamber Cap and unscrew Air Chamber Cap. (SEE PIC A)
2. Remove the Air Chamber Cap from marker body. (SEE PIC B)
3. Wipe off all visible debris and grime from the Air Chamber Cap O-ring with a soft dampened cotton cloth and swab. Lightly apply DP-40 lubricant to the tip of a cotton swab. (SEE PIC C)

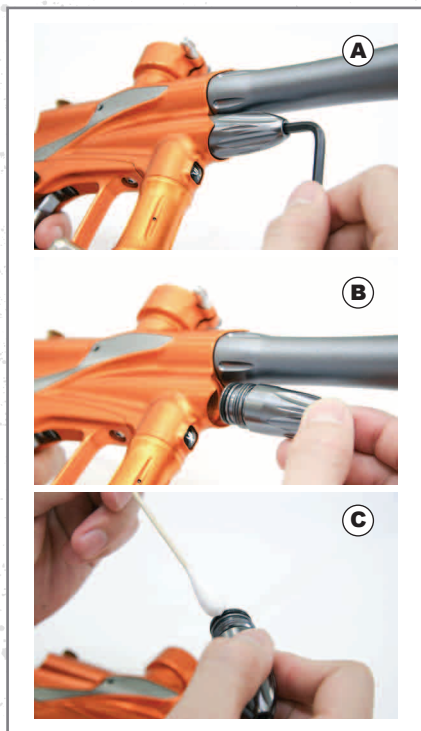

## CLEANING THE AIR CHAMBER MODULE (CONTINUED)

4. Take out the Spring Ring and Valve Pin Spring and Valve Pin from marker body. (SEE PIC D . E)
5. Wipe off all visible debris and grime from the grime from Spring Ring and Valve Pin Spring and Valve Pin. (SEE PIC F . G . H )

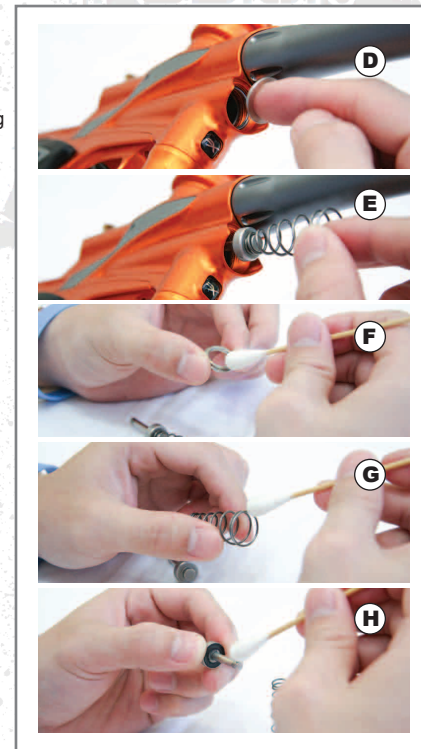

## MAINTAINING THE RAMMER

1. Locate bolt and bolt pin at the back of the marker.
2. Pull bolt pin up and slide bolt out of marker. (SEE PIC A)
3. Use allen wrench (5/32") turn counterclockwise to remove the Ram Cap. (SEE PIC B)
4. Remove the Ram cap from marker. (SEE PIC C)
5. Remove the Ram and Ram spring. (SEE PIC D)



## MAINTAINING THE RAMMER (CONTINUED)

6. Wipe off all visible debris and grime from the Ram and Ram spring with a soft dampened cotton cloth and cotton swab. (SEE PIC E)
7. Lightly apply DP-40 lubricant to the tip of a cotton swab and apply lubricant on the o-rings located on ram. (SEE PIC F)
8. Apply lubricant to the spring on the Ram. (SEE PIC G)
9. Apply lubricant to the o-ring located on the Ram Cap. (SEE PIC H)
10. Reassemble Ram, Ram spring and back cap in reverse order.

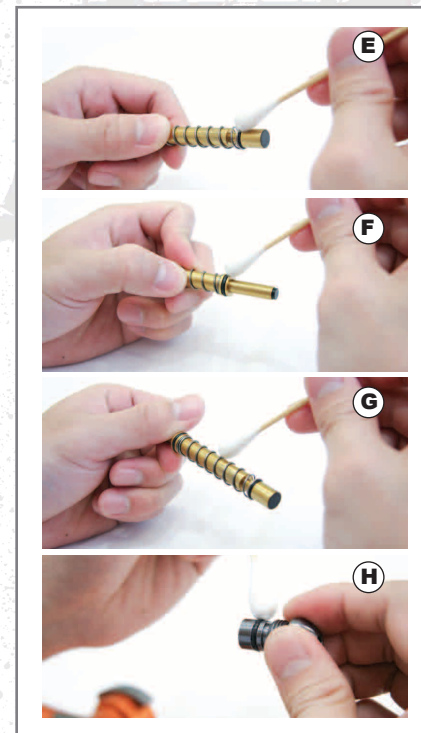

### WARNING

NEVER USE FORCE DURING DISASSEMBLY OR REASSEMBLY. ALWAYS SEEK ASSISTANCE FROM A QUALIFIED AIRSMITH OR CONTACT DP ENGINEERING CUSTOMER SERVICE IF YOU ARE UNCERTAIN OF ANY INSTRUCTIONS DESCRIBED IN THIS MANUAL.



## SEPARATING FX BODY FROM TRIGGER FRAME

1. Carefully remove the 2 hexagonal screws (3/32") holding the left panel in place. (SEE PIC A)
2. Gently secure the base of the connectors and pull up to remove the plugs. DO SO ONE AT A TIME. It may be helpful to use needle nose pliers. Note the location and direction of the connectors on the circuit board for reassembly. (SEE PIC B)
3. Locate screw #1 underneath FX body between OPR and Trigger Guard and screw #2 behind the trigger frame. Using (3/32") allen key wrench, loosen Connector Screw by turning it counterclockwise. (SEE PIC C . D)
4. Separate the FX body from the trigger frame. (SEE PIC E)



## SOLENOID MAINTENANCE

The FX solenoid is a delicate electronic component that requires minimal maintenance or service. DP Engineering does not recommend frequent cleaning of this part, or its internals. The following instructions are provided for reference and for expert airsmiths only.

1. Follow Page 54 continued operation next step.
2. Using (5/64") allen wrench key, locate and remove both screws securing the solenoid to the marker body. (SEE PIC A . B)
3. Once both screws are removed, gently lift and remove the solenoid. (SEE PIC C)
4. Place solenoid on a flat surface, with the wiring harness side facing down and solenoid disassembly screw facing up.
5. Secure base of solenoid casing with an adjustable wrench (not provided). Using a slotted (flathead) screwdriver, remove screw carefully by turning it counterclockwise. Be extremely careful not to strip the screw. (SEE PIC D)

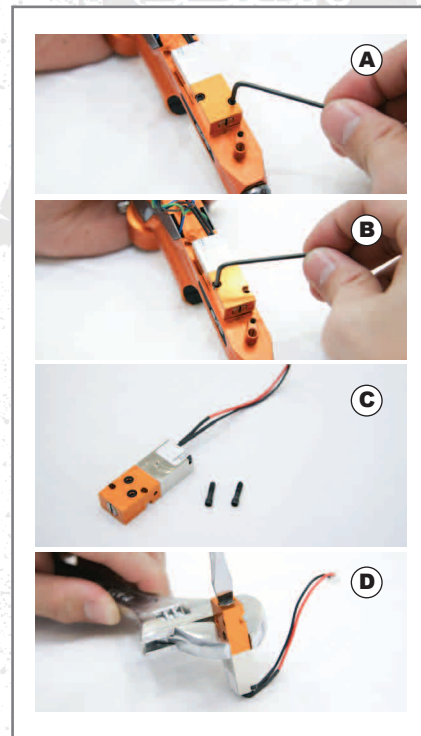

## SOLENOID MAINTENANCE (CONTINUED)

6. Remove solenoid spring. (SEE PIC E)
7. With thin tweezers or needle nose pliers, carefully remove the solenoid piston by gently securing the tip and pulling it out. (SEE PIC F)
8. Carefully inspect and clean solenoid piston o-rings. Make sure the o-rings are not cracked, broken, or show signs of wear. Replace parts if necessary.
9. With a cotton swab, lightly apply a small amount of DP-40 lube to the solenoid piston assembly. (SEE PIC G)
10. Replace in reverse order.

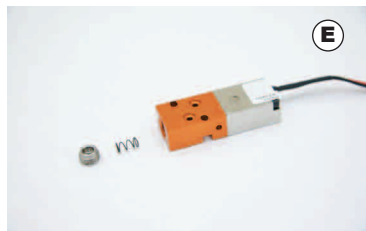

### WARNING

NEVER USE FORCE WHEN REMOVING OR REINSTALLING THE SOLENOID AND ITS SENSITIVE INTERNALS. BE CAREFUL NOT TO BEND, TWIST, OR BREAK DELICATE WIRES, AS DOING SO MAY RENDER THE UNIT INOPERATIVE OR CAUSE IT TO MALFUNCTION.

## REMOVING SWITCHBLADE™ TRIGGER FROM FRAME

1. Locate the two trigger adjustment screws. Use (5/64") allen key wrench to loosen and remove both screws by turning them counterclockwise. Be careful not to misplace the screws. (SEE PIC A . B)
2. Locate trigger removal screw. Use (3/32") allen key wrench to loosen and remove screw by turning it counterclockwise. Carefully pull out screw. Note that the latter part of the screw is a bolt, which the trigger hinges upon. (SEE PIC C)
3. Remove trigger assembly by lifting it up and out of FX trigger frame. (SEE PIC D)



## RAPS™ FLIP LEVER ASA REMOVAL AND MAINTENANCE

The RAPS™ ASA was designed to be virtually maintenance free. However, it may be necessary to occasionally clean and inspect for debris or damage, as either may cause malfunction or leaking of air.

1. Remove macro-line from RAPS™ ASA. **(SEE PIC A)**
2. Remove butterfly grip panels from trigger frame.
3. Disconnect solenoid wiring harness and eye wiring harness from circuit board. **(SEE PIC B)**
4. Locate the three screws securing circuit board to trigger frame and unscrew using a crosshead (Phillips) screwdriver. Carefully remove the circuit board from the trigger frame. **(SEE PIC C)**

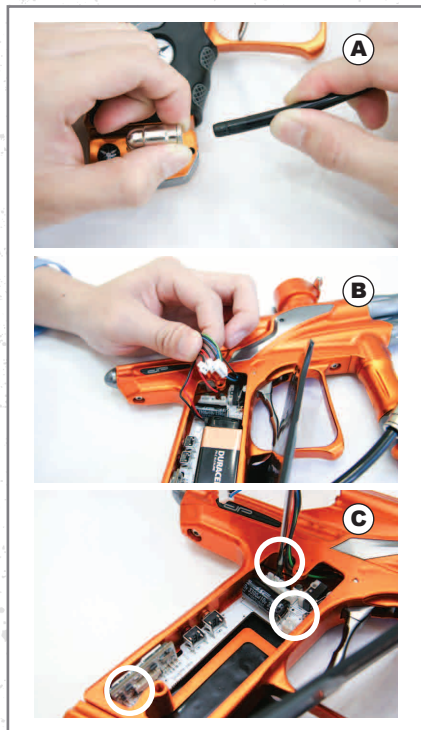

## RAPS™ FLIP LEVER ASA REMOVAL AND MAINTENANCE (CONTINUED)

5. Locate front and back screws within grip frame as illustrated, and unscrew with (3/32") allen key wrench. **(SEE PIC D . E)**
6. Slide RAPS™ ASA forward on rail to remove from frame. **(SEE PIC F)**
7. Locate hex screw on RAPS™ ASA casing.
8. Using (5/64") allen key wrench, loosen and remove screw by turning it counterclockwise. **(SEE PIC G)**
9. Remove RAPS™ lever and piston from RAPS™ casing as shown.
10. Check spring for proper tension. Replace if worn or damaged.

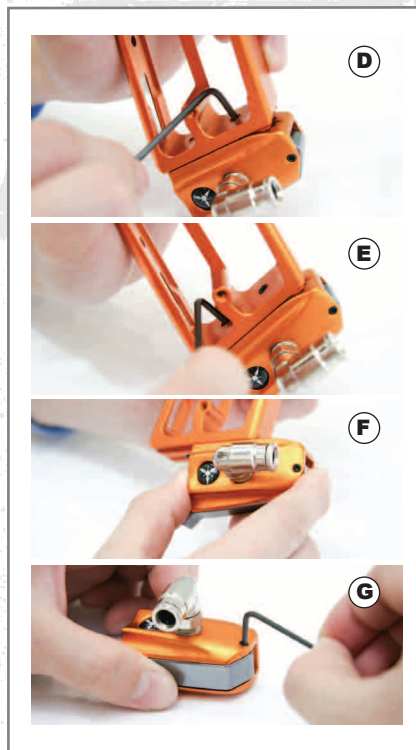

## RAPS™ FLIP LEVER ASA REMOVAL AND MAINTENANCE (CONTINUED)

11. Use a lightly dampened cloth and/or cotton swab to remove debris or grime from all RAPS™ ASA components, including the piston, spring, lever, and casing. (SEE PIC H)
12. Clean and inspect o-ring located on the base of the piston. Replace o-ring if it appears worn, cracked, or damaged. Using a cotton swab, apply a small amount of DP-40 lubricant on the o-ring. (SEE PIC I)
13. Make sure the spring is properly seated on the piston, then reassemble the RAPS™ ASA in the reverse order of assembly. (SEE PIC J)



### WARNING

REMEMBER TO DE-GAS THE FX BEFORE SERVICING THE RAPS™ ASA. FOLLOW INSTRUCTIONS PREVIOUSLY OUTLINED ON PAGE 41 TO SAFELY AND PROPERLY REMOVE EXCESS AIR FROM THE MARKER.



# TROUBLESHOOTING

PROBLEM	POSSIBLE CAUSE	SOLUTION
FX will not turn on	Not activated	Hold down operating button for more than 4 seconds
	Low battery power	Replace with fresh battery
	Battery is connected incorrectly to the PC board	Check to see if the battery cable is connected correctly to the terminal
FX will not fire	Low battery power	Replace with fresh battery
	Low air pressure	Refill the air system
	OPR pressure is too low	Adjust OPR pressure without paintball present

PROBLEM	POSSIBLE CAUSE	SOLUTION
FX will not fire with sensor system on	No paintball present	Turn on the loader
	Sensor system is unclean	Remove and clean sensor eye
	Broken paintball inside	Refer to bolt maintenance
	Ball detent is damaged	Change ball detent
FX will not cycle completely	Air pressure is too low	Adjust the operating pressure to 150 to 200 psi
	Dwell time is too short	See page 33 " Solenoid Dwell adjust "
	Low battery power	Change battery
	Hammer o-ring is worn	Change o-ring
	Hammer o-ring lubricant is exhaust	Lubricate the o-ring with Dow-55 lubricant

PROBLEM	POSSIBLE CAUSE	SOLUTION
Air leaking from barrel area	Poppet valve no seal	Clean air chamber module
Paintball breaking out of the barrel	Barrel size does not match paintball's	The stock barrel size is 0.690, change if necessary
Paintball chopping internally	Ball detent is worn	Change ball detent
	Sensor system is not on	Switch it to ON
	Low battery power	Replace with fresh battery



# PARTS DIAGRAM AND TABLE

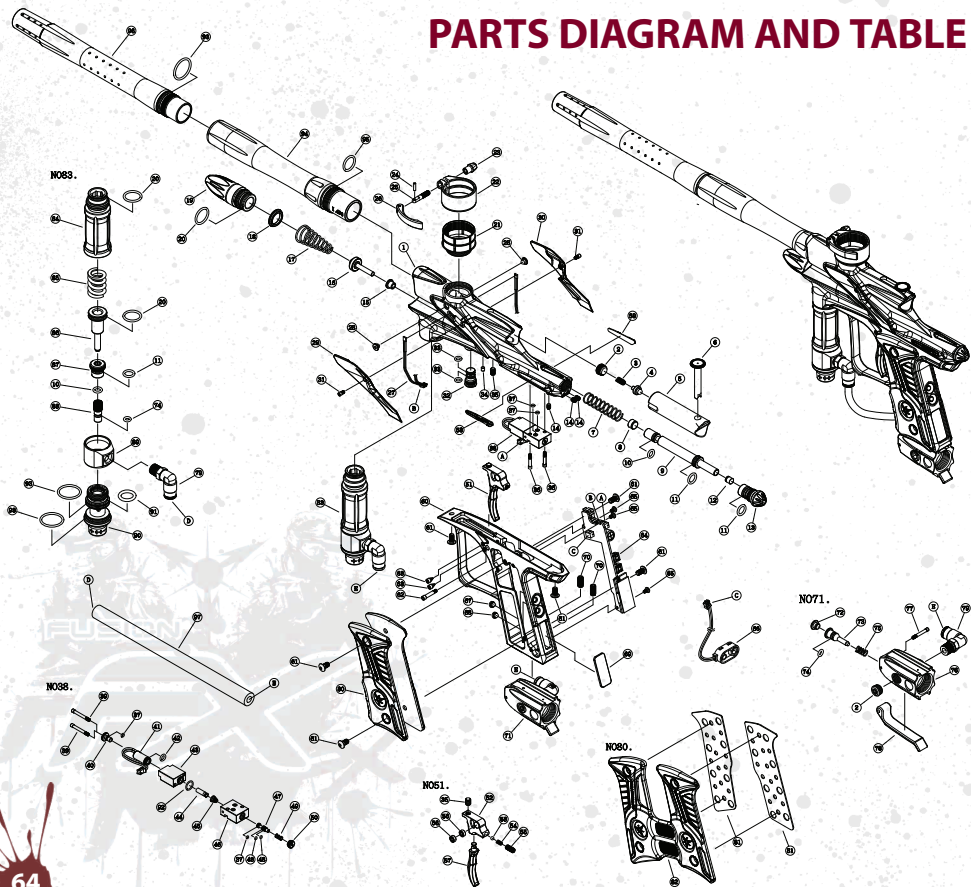

NO	ITEM NUMBER	O'ty	NOTE
1	20-B01276-301-PFX00B	1	
2	20-W10560-000-PM31	2	1/8"-27NPT-6.5L
3	20-G10310-000-PFX00B	1	
4	20-H05630-000-PFX00B	1	
5	20-E20132-000-PFX00B	1	
6	20-H05602-000-PFX00B	1	
7	20-G01260-000-PFX00B	1	
8	20-E01180-000-PFX00B	1	
9	20-H05612-000-PFX00B	1	
10	20-F01520-000-PFUS0A	2	Ø5.29 * Ø1.78
11	20-F01530-000-PFUS0A	3	Ø7.65 * Ø1.78
12	20-E01170-000-PFX00B	1	
13	20-B10373-301-PFX00B	1	
14	20-W10930-000-PTHR7A	3	#5-40UNC-3/16"L
15	20-E20140-000-PFX00B	1	
16	20-H05624-000-PFX00B	1	
17	20-G10320-000-PFX00B	1	
18	20-H01030-000-PFX00B	1	
19	20-B25693-301-PFX00B	1	
20	20-F01510-000-PFUS0A	3	Ø14 * Ø1.78
21	20-B25642-301-PG300B	1	
22	20-B16133-301-PG300B	1	
23	20-H03150-000-PG300B	1	
24	20-H05560-000-PFUS0A	1	
25	20-C25030-104-PG300B	1	
26	20-B30674-301-PG300B	1	
27	20-W23660-000-PFX00B	1	
28	20-F10200-000-PFX00B	2	
29	20-B30874-301-PFX00B	1	
30	20-B30884-301-PFX00B	1	
31	20-W11020-000-PSPI0B	2	#3-56UNF-4L
32	20-B20272-307-PFX00B	1	
33	20-F01840-000-PFX00B	2	Ø5.5 * Ø1.5
34	20-W63020-000-PREV0B	1	Ø3 * T3
35	20-W10950-000-PTHR7A	2	#8-32UNC-6.35L
36	20-W11060-000-PFX00B	2	#3-56UNF-10L
37	20-F01780-000-PG300B	4	Ø2 * Ø1
38	20-A06240-307-P00B	1	
39	20-W10780-000-PFUS0A	2	#3-56UNF-19.8L
40	20-C20060-104-P00B	1	
41	20-A06232-307-PFX00B	1	
42	20-F01850-000-PFX00B	1	Ø5 * Ø1
43	20-C01052-104-PFX00B	1	
44	20-C20053-104-PTHR7A	1	
45	20-G10340-000-PFX00B	1	
46	20-B20253-307-PFX00B	1	
47	20-H05640-000-PFX00B	1	
48	20-F01700-000-PFUS0A	2	Ø2 * Ø1

NO	ITEM NUMBER	O'ty	NOTE
49	20-G10220-000-PFUS0A	1	
50	20-H03110-000-PFU30A	1	
51	20-A06270-301-PFX00B	1	
52	20-B30824-301-PFX00B	1	
53	20-W01090-000-PT00	1	Ø3.5
54	20-G01250-000-PREV0B	1	
55	20-W11010-000-PFUS0A	1	#8-32UNC-3/8"L
56	20-W60010-000-PREV0B	2	
57	20-B30864-301-PFX00B	1	
58	20-F10180-601-PFX00B	1	
59	20-F10190-601-PFX00B	1	
60	20-B05295-301-PFX00B	1	
61	20-H03180-000-PREV0B	6	#8-32UNC-5/16"L
62	20-H03210-000-PSPE0B	1	#3-56UNF-15L
63	20-W11012-000-PFUS8A	2	#8-32UNC
64	20-W23680-000-PFX00B	1	
65	20-W10840-000-PFUS0A	3	#3-56UNF-5/32"L
66	20-W23510-000-PFUS0A	1	
67	20-B10412-300-PFX00B	1	
68	20-B10392-305-PFX00B	1	
69	20-E10200-000-PFX00B	1	
70	20-W11040-000-PSPI0B	2	#10-32UNF-5/16"L
71	20-A01310-301-PFX00B	1	
72	20-E01130-000-PFUS0A	1	
73	20-H05540-000-PG300B	1	
74	20-F01590-000-PFUS0A	2	Ø3.69 * Ø1.78
75	20-G10250-000-PFUS0A	1	
76	20-B25634-301-PG300B	1	
77	20-W10810-000-PFUS0A	1	#3-56UNF-17.3L
78	20-B30684-301-PG300B	1	
79	20-A01170-104-PREV0B	2	1/8"NPT #
80	20-A13900-601-PFX00B	1	
81	20-C10122-000-PSPI0B	1	
82	20-E05260-610-PFX00B	1	
83	20-A20300-301-PFX00B	1	
84	20-B16273-301-PFX00B	1	
85	20-G10330-000-PFX00B	1	
86	20-B10382-307-PFX00B	1	
87	20-B20262-307-PFX00B	1	
88	20-H03223-000-PFX00B	1	
89	20-B16254-301-PFX00B	1	
90	20-B16263-301-PFX00B	1	
91	20-F01830-000-PFX00B	1	Ø13.95 * Ø2.62
92	20-F10860-000-PFX00B	1	Ø5.5 * Ø1
93	20-F01540-000-PFUS0A	3	Ø18.77 * Ø1.78
94	20-B16244-301-PSPE0B	1	
95	20-F01820-000-PSPE0B	1	Ø12.42 * Ø1.78
96	20-B15942-301-PT00	1	
97	20-E02092-000-P031	1	Ø1/4 * 130L

## STATEMENT OF LIABILITY

The manufacturer assumes no responsibility for this product's safe operation upon sale or distribution. PROPERTY DAMAGE, BODILY INJURY, OR DEATH could occur due to misuse, abuse or failure to follow the manufacturer's instructions stated in this manual. The manufacturer will assume no responsibility for physical injury or property damage resulting from the use of this marker. The information in this document is subject to change without prior notice. The manufacturer assumes no responsibility for any errors that may appear in this document.

## DISCLAIMER

Notice is hereby given that this owner's manual is part of the article owned in whole by the manufacturer, known as indicated by this disclaimer and all illustrations within the manual. All rights for manufacturing and reproducing of such articles or any part thereof are reserved by the manufacturer. Neither said article nor any part thereof may be manufactured or reproduced in any way except by the written authorization of the manufacturer. All proprietary truths and information are the sole property of the manufacturer.

## LIMITED LIFETIME WARRANTY

DANGEROUS POWER™ warrants this FX paintball marker, to the initial retail purchaser, to be free from defect in original materials and/or workmanship for the lifetime of the marker, with the following exceptions:

1. Disposable parts (batteries, o-rings, seals, micro switch, air pressure hose, rubber and/or plastic material parts, etc.) are not included in this limited lifetime warranty.
2. Electronic parts on this marker are fully warranted for 30 days from the original date of purchase.
3. Bolt and striker systems of this marker are fully warranted for 6 months from the original date of purchase.
4. Surface damages (scratches and nicks) or operation failure due to accident, neglect, modification, normal wear, operator error, maintenance by anyone other than an authorized dealer or agent, misuse, improper disassembly and reassembly, are expressly not covered under this warranty.

Purchaser is responsible for all rendered services not covered under this limited lifetime warranty, including any applicable shipping costs, labor, and/or installation.

DANGEROUS POWER™ reserves the right to determine the legitimacy of claimed defective original parts and their eligibility for coverage under the terms of this warranty. DANGEROUS POWER™, its authorized dealers, affiliates, and/or agents, will not be held liable under this warranty, state, federal, or common law for any product failure, personal injury, or property damage resulting from improper use and/or alteration of this product. Any attempt to alter the trigger assembly will instantly void your warranty and may result in serious injury. Any attempt to alter basic marker parts without prior written consent from the manufacturer will result in automatic default of all expressed warranties.

This limited lifetime warranty is non-transferable and is valid only upon presentation of a completed warranty registration card and original proof of purchase. There are no other warranties or guarantees, expressed or implied, made by the manufacturer on this paintball marker.

**PAINTBALL MARKERS ARE NON-REFUNDABLE AND ARE NOT SUBJECT TO EXCHANGE FROM MANUFACTURER.**





# DP ENGINEERING

## Product Registration Card

Fill out all of the information below completely. To activate your warranty, visit [www.dangerouspower.com](http://www.dangerouspower.com) and click on "SUPPORT" to register your product within 7 days of purchase. Keep this card and your receipt or proof of purchase - you will be asked to include both when sending in your product for warranty service.

Name \_\_\_\_\_

Address \_\_\_\_\_ Apt/Suite # \_\_\_\_\_

City \_\_\_\_\_ State \_\_\_\_\_ Province \_\_\_\_\_

Zip/Postal Code \_\_\_\_\_ County \_\_\_\_\_ Country \_\_\_\_\_

Phone (\_\_\_\_) \_\_\_\_\_ Fax (\_\_\_\_) \_\_\_\_\_

Email \_\_\_\_\_

Name of Product Purchased \_\_\_\_\_

Date of Purchase \_\_\_\_\_ (dd/mm/yy) Product Color \_\_\_\_\_

Place of Purchase \_\_\_\_\_

Product Serial Number (if applicable) \_\_\_\_\_

I guarantee all of the information completed above to be true and correct to the best of my knowledge.

Signature \_\_\_\_\_

Date \_\_\_\_\_

Visit [www.dangerouspower.com](http://www.dangerouspower.com) for more information on how to claim warranty.





Copyright © Dangerous power. The "Dangerous Power" logo and "dp" logo are registered trademarks. All rights reserved.